

Article number: 204801V10250ALOS

Description: E+G Retaining tube without scales - GN 480.1-V10-250-AL-OS

Measures

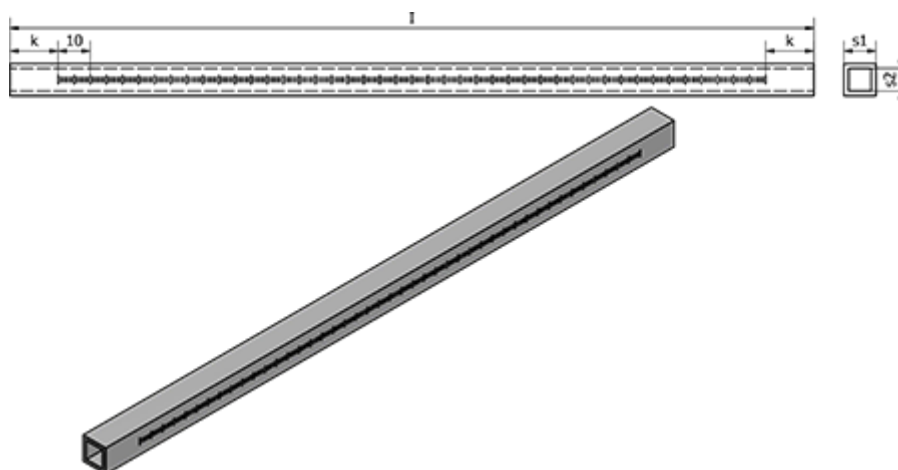

l	= 250
k	= 15
s1	= V10
s2	= 7
Weight (g)	= 32